

Varenummer: 0102228  
 Beskrivelse: Seeger låsering J 500 DIN 472  
 Fjederstål

## Mål

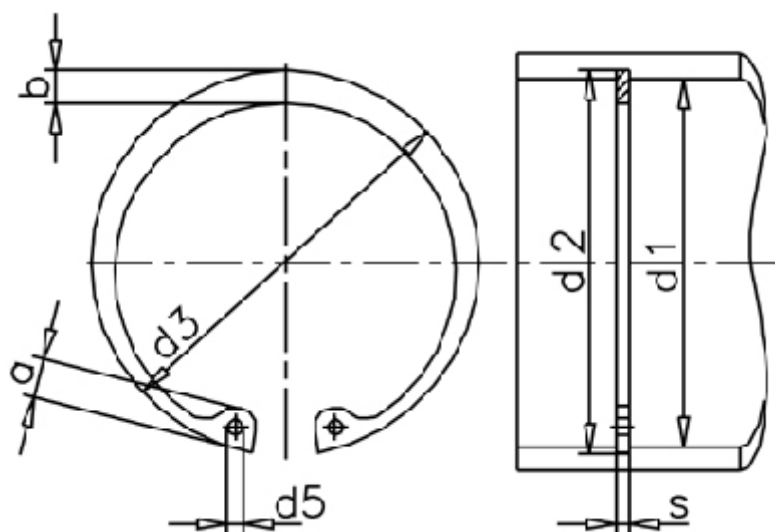

a max	= -	FN kN	= 1588.00	t	= 6.00
AN mm <sup>2</sup>	= 9530.0	FRg kN	= 125.0	Tang	= ZGJ-5
b	= 26.0	FR kN	= 1256.0	tol	= -0.15
Betegnelse	= J 500	g	= 6.0	tol	= +3,00-1,50
d1	= 500	K kN-mm	= 2878.0	tol	= +1,00
d2	= 512.0	m min	= 7.20	vægt kg/1000	= 1730.00
d3	= 520.00	Nominel træk	= 18.0		
d5 min	= 6.0	s	= 7.00		